



OPTO ENGINEERING

ILLUMINATOR DATA

LTZPFE160-00-3-IR850-24V

Lighting Dimension

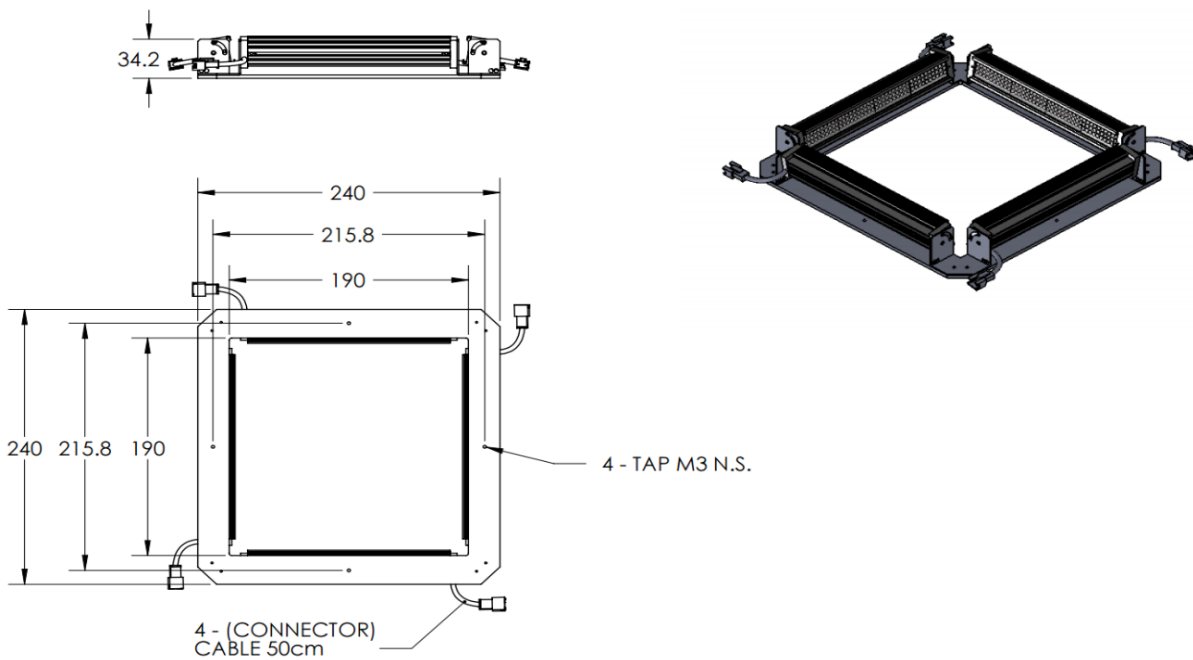

Mechanical Information

Casing Material	Aluminium
Storage Temperature Range	0 - 45°C
Storage Humidity Range	20 - 85%
Weight	740g
Length / Outer Diameter	240mm
Width / Inner Diameter	190mm
Thickness / Height	34.2mm



OPTO ENGINEERING

ILLUMINATOR DATA

LTZPFE160-00-3-IR850-24V

Lighting Information			
Part Number	LTZPFE160-00-3-IR850-24V		
LED Color	IR850		
Wavelength	850nm		
Working Distance	280 mm	291 mm	302 mm
Intensity ($\pm 15\%$)	-	-	-
Illumination (number of row)	3		
Illumination Active Area	Active Length / Outer Dia.	240 mm	
	Active Width / Inner Dia.	190 mm	
Emission angle	0		
Eye Safety Class (IEC62471)	EXEMPT		
Chromaticity Table For White colour only	Nil		

Electrical Information	
Rated Constant Voltage	24V $\pm 2\%$
Rated Constant Current	720mA
Power Consumption	17.28W
Casing temperature, After 60 minutes operation	TBA

Strobe Mode Specification		
*Normal Strobe Voltage	24 V	
*Normal Strobe Current	720 mA	
Overdrive Voltage Range	Min: 36V	Max: 48V
Overdrive Current Range	Min: 4.8 A	Max: 4.8 A
Recommended Overdrive Voltage	36V	
**Max. Trigger Pulse Duration	10 msec	
**Max. Duty Cycle	10%	

*Normal strobe means the lighting is operated using the rated power. Overdrive means the power supplied to the lighting exceeded the rated power.

**Overdrive condition must not exceed the max. trigger pulse duration and max. duty cycle.

ILLUMINATOR DATA

LTZPFE160-00-3-IR850-24V

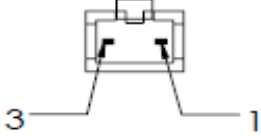
Connection Information			
Connector Type (Default)	JST SMR-03V		
Cable Length	50 cm		
Pin Configuration 	Pin	Signal	Cable Colour
	1	LED +	Red
	2	N.C	-
	3	LED -	White
			

Additional Information	
Additional Cooling Method	Attached to machine part for better heat dissipation
Intensity Controller Selection	SD, ST, ANG, LC, SDA, SDP series
CE Conformity	YES
RoHS Compliance	YES

Application	
Illumination Type	Direct Illumination
Application Use	Label Inspection, Character Inspection, Code Recognition



OPTO ENGINEERING

ILLUMINATOR DATA

LTZPFE160-00-3-IR850-24V

Lighting Pattern				
Working Distance	For further details please contact us.			
Display and Image				
Data Results	Horizontal	Meas.(mm)	Vertical	Meas.(mm)
	90%		90%	
	80%		80%	
	70%		70%	
	60%		60%	
	50%		50%	
	40%		40%	
	30%		30%	
	20%		20%	
	10%		10%	